

ColibriNANO on the Internet

There are several ways to put the ColibriNANO into operation. Via a USB connection with a PC and start of the ExpertSDR2 software, via the home network (LAN / WLAN) with a server and the software RemoteClient ExpertRC or via the Internet (www) with port forwarding and web client.

1) Connecting ColibriNANO to a PC / notebook

By default, the ColibriNANO is connected directly to a PC / notebook via its USB port and the "ExpertSDR2 ColibriNANO" software (ExpertSDR2-1.2.0_Colibri NANO_setup.exe) is started on the computer. The actual software can be found at (1). The ColibriNANO is not network compatible at home, and a connection to the LAN / WLAN home network or the Internet is initially not possible.

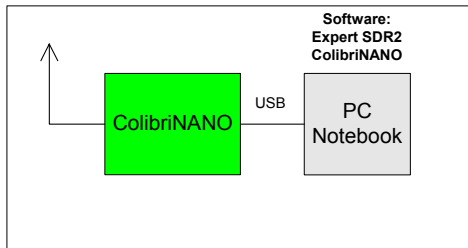

Picture 1: Connection of the ColibriNANO via USB interface to the PC / notebook

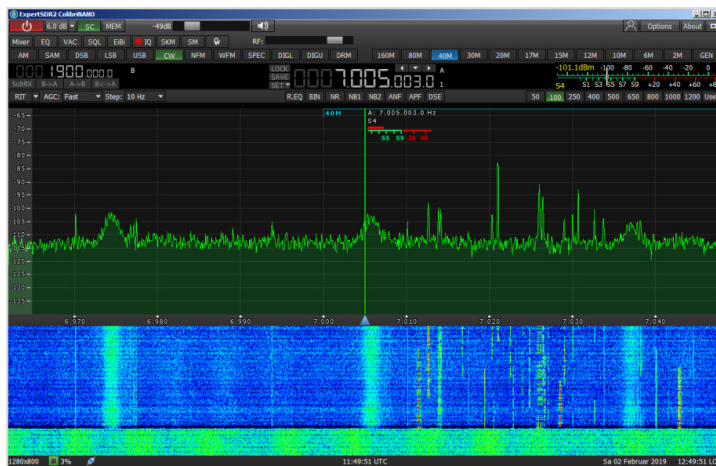

Picture 2: Program "ExpertSDR2 ColibriNANO" started on the PC

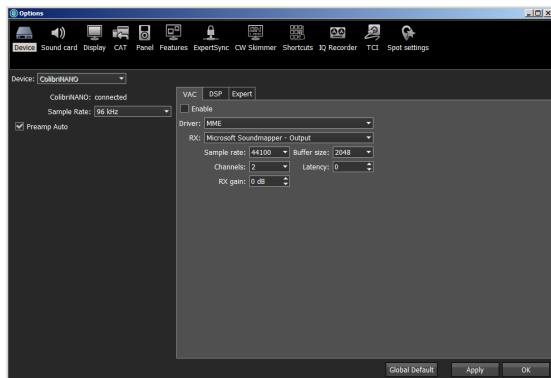

Picture 3: Selectable setting of the ColibriNANO

2) Connecting ColibriNANO to the local LAN / WLAN network

In order for the ColibriNANO to be accessible via the home network, it needs a PC as a server. However, a small PC is enough for this, such as a Raspberry Pi3. To do this, connect the ColibriNANO

via its USB interface to the RPi3 and the RPi3 via LAN cable to the router (**Figure 4**). In order for the Raspberry to recognize the Colibri, one must first use the image software "**ExpertRS 0.4.0**" (RPi3OpenWRT_Remote_0.4.0_16042018.img) (**2**) on the SD card (16GB) of the RPi3. After starting, the router automatically assigns the RPi3 an IP address, via which the receiver in the home network can then be reached. The Raspberry Pi3 now acts as an SDR server and the ColibriNANO as a client. To find out the address of the RPi3, open the router under Home Network -> Networks and find the new address there (**Picture 6**). The address of my RPi3 was 192.168.178.55.

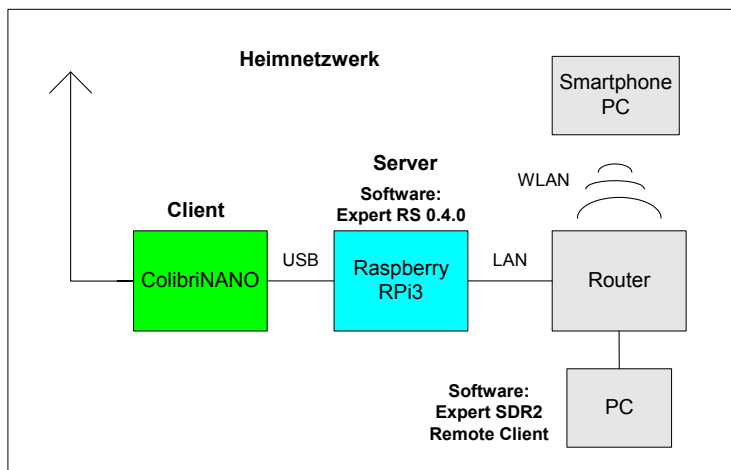

Picture 4: Connect the ColibriNANO to the router via RPi3

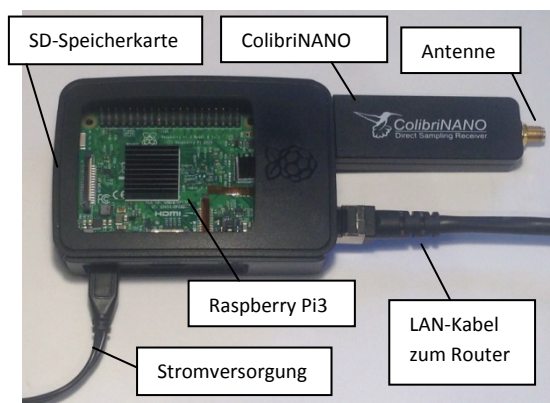

Picture 5: ColibriNANO with Raspberry Pi3 in remote server configuration

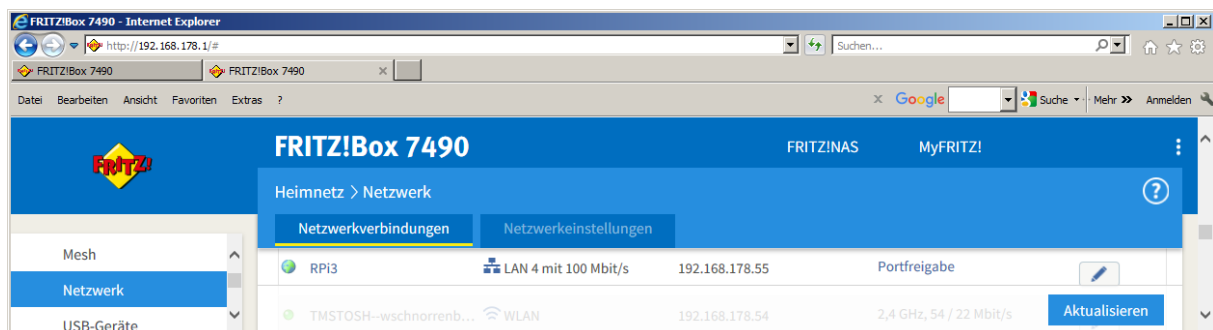

Picture 6: IP address of the RPi3, assigned by the router (FritzBox)

Using this IP address, the ColibriNANO can then be opened and operated in the home network of all PCs, Smartphones or tablets via LAN / WLAN. The maximal Sample rate of the spectrum is 384kbit in remote client mode. Special plug-ins like Flash or Java are not need to be installed. The browser used

must only be HTML5-enabled, such as Chrome, Firefox, Opera and Apple Safari. **Picture 7** shows the "Image" of the ColibriNANO on a Windows PC (WIN7) under Firefox and in **Picture 8** on an iPad under Safari.

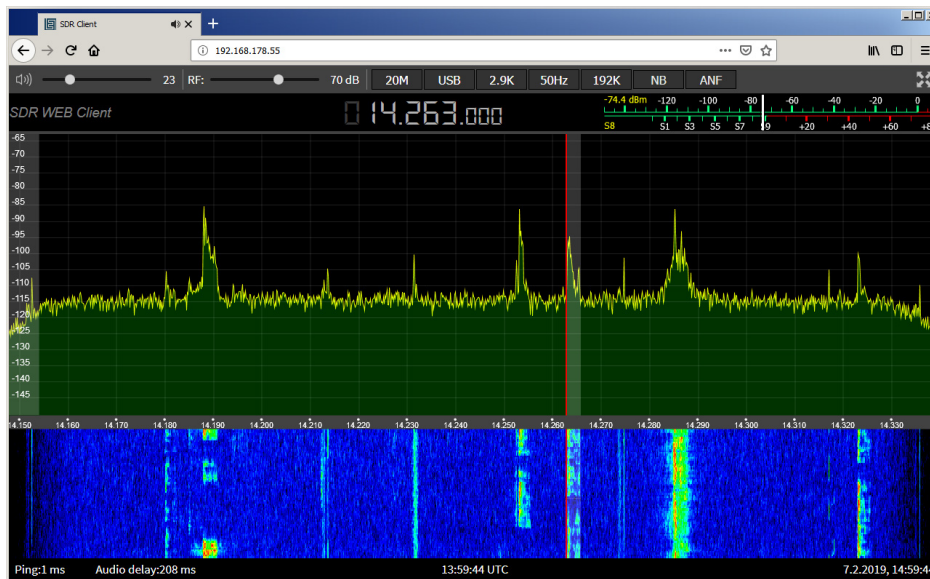

Picture 7: ColibriNANO on the PC in the home network (SDR Web Client), Firefox browser

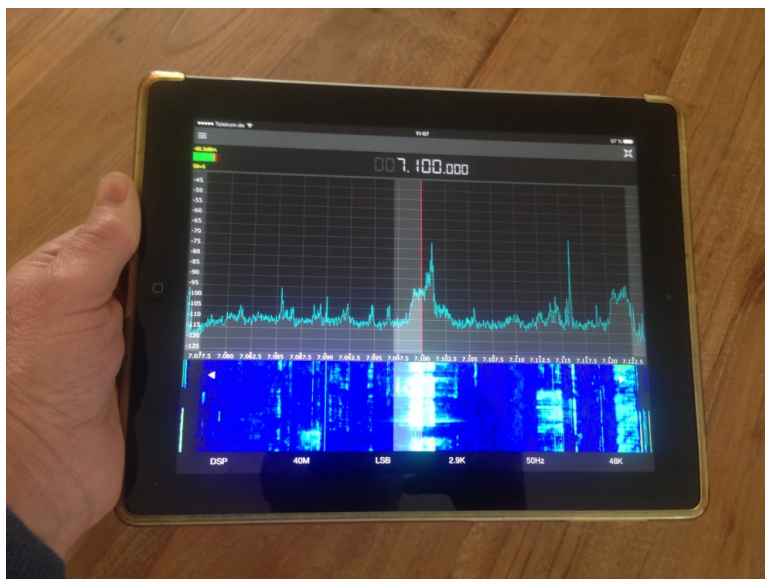

Picture 8: ColibriNANO on the iPad4 via Safari

As can be seen in **Picture 7 and 8**, the ColibriNANO data is heavily compressed when transferred to the network, which limits the overall settings. A very much detailed image is provided by the PC software "**ExpertRC 1.2.0**" (ExpertSDR2_1.2.0_Remote_Client_setup.exe) (**2**) in picture. **10**. After installing and starting the program, go to the "Device" tab and enter the server address and server port 5050 (Picture 9). Possibly this makes the program at startup already automatically. Then select "Search" and the PC will find the address of the ColibriNANO in the home network. To start the program opens the image and the receiver can be optionally set under Options (sample rate, bit rate, etc.). The maximal selectable sampling rate is 384kbit/s.



Picture 9: Entering the server address and server port

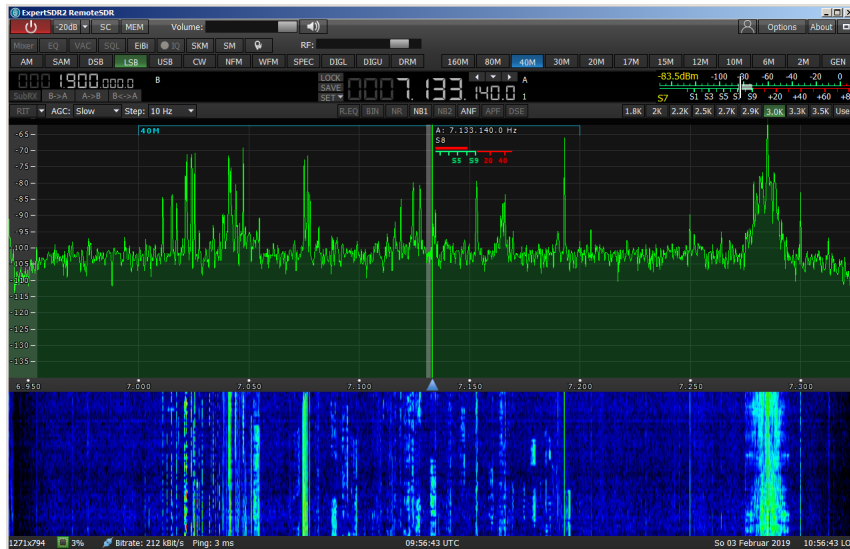

Picture 10: ColibriNANO in the network on the PC, after starting "ExpertSDR2 RemoteClient"

Meanwhile, Expert Electronics released a PC version of **ExpertRS** (Remote Server) and **ExpertRC** (Remote Client) (2) with additional capabilities and improvements. This software uses a PC as a server.

3) ColibriNANO to the Internet

similar to an IP-WebCam, also the ColibriNANO can reach from the Internet (**Picture 11**). For this, a port forwarding to port 5050 (default ExpertRS) and port 80 for remote control of the receiver via web client must be performed in the router (**Picture 12**). Subsequently, the Receiver is worldwide reachable via his public IP address on the Internet.

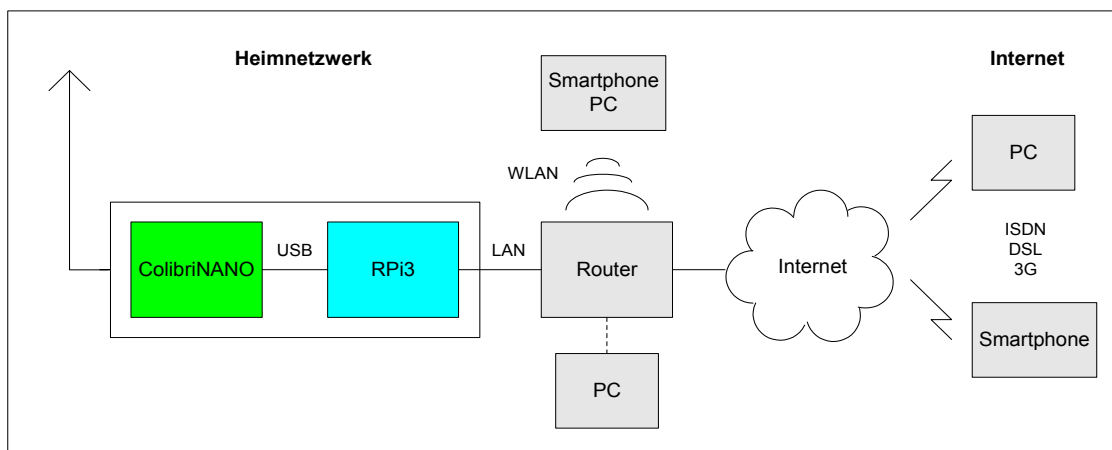

Picture 11: ColibriNANO on the internet

The connection works with PC, Notebook or Smartphone/Tablet via a LAN / WLAN connection, as well as mobile over 3G/LTE.

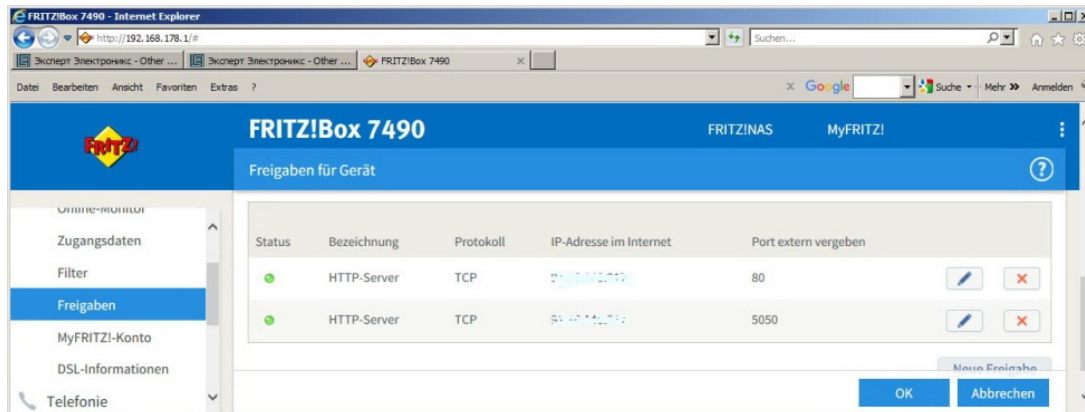

Picture 12: Server Internet IP address and port forwarding in the router

With the Internet access of the receiver, the user opens up completely new possibilities. For example, I use the web client at home from the office or garden to inform myself about the conditions on the bands or just to listen, without having to go to the RadioShack. When I go on vacation, I leave at home only the RPi3 and ColibriNANO turned on. No matter where I am, I can reach my ColibriNANO from anywhere on the Internet. A PC or other devices do not have to remain switched on in the RadioShack, the RPi3 with its low power consumption acts alone as a remote server.

Furthermore, the ColibriNANO could also be installed in an exposed, low-noise location (mountain lodge) and used from home over the Internet as an additional, sensitive receiver. All you need is an internet connection of the ColibriNANO. The latency is low, about 100 ... 300ms.

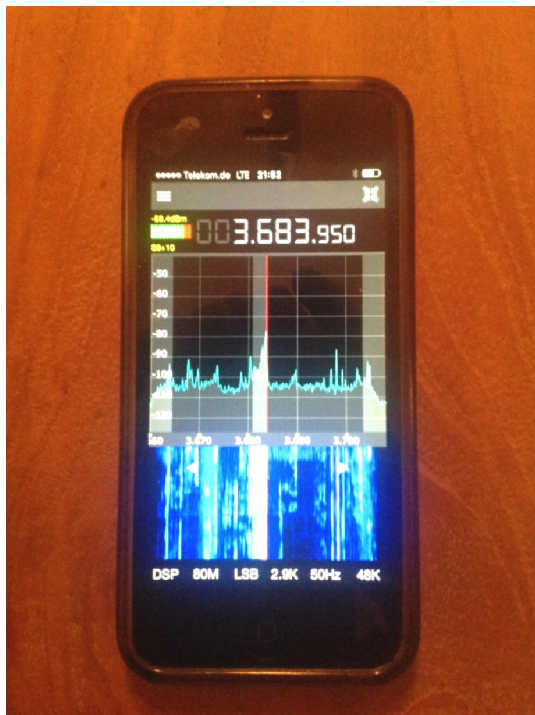

Picture 13: ColibriNANO on the way, launched on a smartphone mobile under LTE / 3G

Note: For security reasons, some DLS providers disconnect the connection to the router once a day and subsequently assign a new public IP address. If that happens, the ColibriNANO is no longer

available. If we use a FritzBox, the current IP address can be found under "www.MyFritz.net" of the home router over the Internet to determine again. MyFritz is an AVM server that polls the public IP of the home router at regular intervals.

To bypass this procedure, you can also log in to a DynDNS provider (Dynamic DNS Service), such as www.dyndns.org or Securepoint . Then the Colibri gets its own Internet address (host name, domain), such as "www.Name.spdns.org", via it can be reached on the Internet (**Picture 14**). When the address is called up, it is automatically redirected to the current IP address.

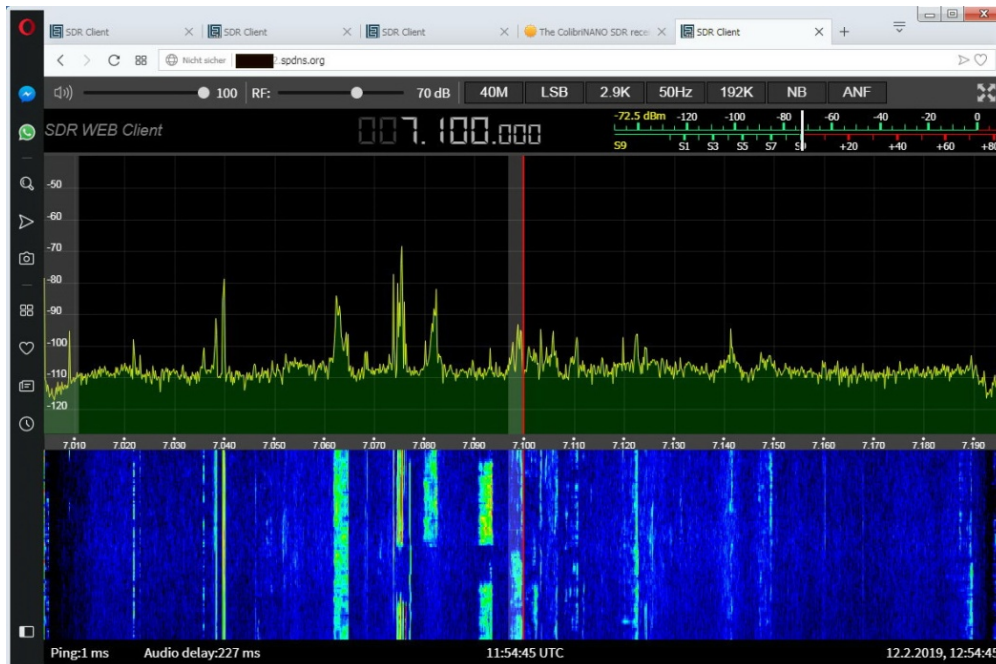

Picture 14: ColibriNANO called via its host name <http://name.spdns.org> in the Internet

The USB stick and the RPi3 should be connected via a USB cable so that they are physically separated from each other (**Picture 15**). In the case of a direct connection as shown in **Picture 5**, otherwise interference (cracking noise) from the open, unshielded RPi3 board could be transmitted to the receiver. Folding ferrites via the power and USB cables are always useful.



Picture 15: Direct sampling SDR receiver with RPi3 as server

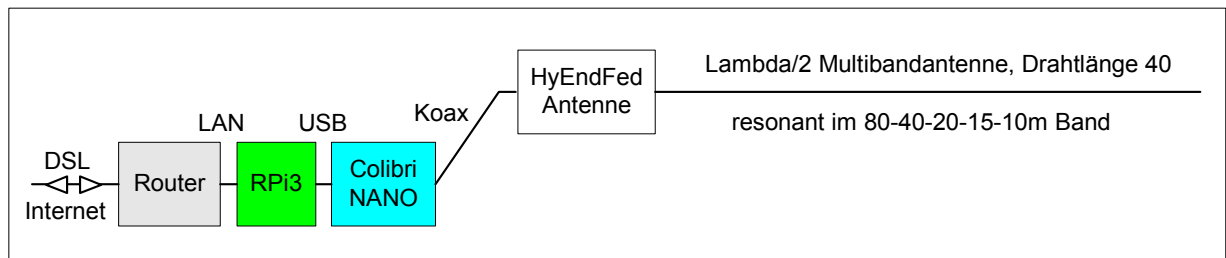

Picture 16: Structure of a self-sufficient IP receiver with End-Fed KW multi-band antenna

To test a ColibriNANO on the Internet, you can call the address "<http://vpn.laboenligne.ca>" by Pascal, VA2PV (3). Pascal provides the internet access to his ColibriNANO freely here.

Werner Schnorrenberg

DC4KU

26.02.2019

Literatur

(1) <https://eesdr.com/en/products-en/receivers-en/colibrinano-en#software>

(2) <https://eesdr.com/en/expertsdr2-en/software-en>

(3) <https://forums.qrz.com/index.php?threads/the-colibrinano-sdr-receiver-review.591660>